

Form 18110  
October, 1925  
PRINTED IN U. S. A.

# LIST OF PARTS



## MACHINES Nos. 147-2 and 147-23

\*\* A TRADE MARK OF  
THE SINGER MANUFACTURING COMPANY

From the library of: Diamond Needle Corp

# INSTRUCTIONS FOR OILING

---

To ensure easy running and prevent unnecessary wear of the parts which are in movable contact, the machine requires oiling and when in continuous use, "TYPE B" or "TYPE D" OIL, sold only by Singer Sewing Machine Company, should be applied at least twice each day to all oil holes marked "OIL".

"TYPE D" OIL is stainless.

## INDEX

---

	PAGE
ACCESSORIES.....	28
BELT GUARD.....	29
BENCH STAND.....	30
EDGE GUIDE.....	29
FOOT LIFTER PARTS.....	29
IRON BASE.....	28
KNEE LIFTER PARTS.....	30
MACHINE NO. 147-2.....	7
"    "    147-23.....	18
NUMERICAL LIST OF PARTS.....	30
THREAD UNWINDER (for two spools).....	30
"    "    (for four spools).....	31

From the library of: Diamond Needle Corp

COPYRIGHT, U. S. A., 1922, 1924 AND 1925  
BY THE SINGER MANUFACTURING COMPANY  
ALL RIGHTS RESERVED FOR ALL COUNTRIES

## INSTRUCTIONS FOR ORDERING

In ordering from this list, use **ONLY** the **PART** number in the **FIRST** column.

The number stamped on a Sewing Machine part is in every case the number of the single part only.

Every combination of parts sent out as such has its specific number, which, although not stamped on the parts, must be used when ordering the combination.

Each number always indicates the **SAME PART** in whatever list it appears, or for whatever machine.

The letters after some of the numbers indicate the style of finish only, as follows:

- A. Hardened, Polished and Plated.
- B. Polished and Plated.
- C. Hardened only.
- D. Polished only.
- E. Soft, not Polished.
- F. Hardened and Polished.
- G.
- H. Blued.
- J. Plated only.
- K. Hardened and Plated.
- L. Brass or Gilt.
- M. Oxidized.
- P. Japanned.
- R. Parkerized.
- T. Copper-plated.

These letters **MUST BE USED** *when* they appear in the list, and **AFTER** the number *as* in the list.

In this series:

1 to 1500 and 50001 to 51500 are Screw Numbers.

1501 to 1800 are Nut Numbers.

1801 to 2000 are Roller Numbers.

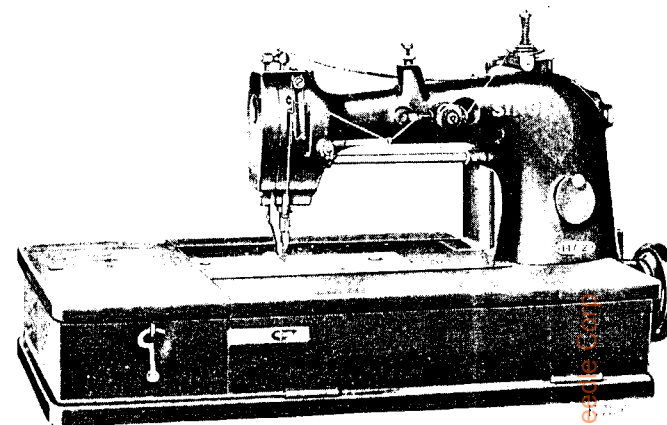
2001 to 50000 and 52001 and upward are numbers of Machine Parts.

The figures in the second column refer only to the plates, illustrating the parts, and are **NOT TO BE USED** in ordering.

Parts marked with an asterisk (\*) are furnished only when repairs are made at factory.

## LIST OF PARTS COMPLETE

FOR



### MACHINE No. 147-2

FOR CLOTH OR LEATHER, STITCHING GLOVES, CLOSING SHOES; ALSO FOR BINDING LIGHT AND MEDIUM FABRICS OR LEATHER. ONE NEEDLE, ONE LOOPER, ALTERNATING PRESSER. INDEPENDENT UPPER AND UNDER FEED.

NO.	PLATE	NAME
*54130	-----	Arm, upper and lower (solid) with 948D and 54034.....
42366	8901	Arm Oil Pad (braided cotton) for oiling Arm Rock Shaft Front Bearing.....
56006	8901	Arm Oil Pad (braided cotton) for oiling Arm Rock Shaft Intermediate Bearing.....
11119	8901	Arm Oil Tube with 29599, for oiling 64321
40217	8923	" " " " " " " 54147
29599	8901	" " " Packing (felt).....
54131	8925	" Rock Shaft.....
64386	8901	" " " Bushing (back).....
446c	8901	" " " " " Set Screw
64388	8901	" " " " (intermediate)
423c	8901	" " " " " Set Screw.....

NO.	PLATE	NAME
52045	8901	Arm Rock Shaft Bushing Oil Pad (braided cotton).....
54004	8901	Arm Rock Shaft Collar with two 453c....
453c	8901	“ “ “ “ Set Screw.....
54005	8901	“ “ “ Crank (back) with two 50083c.....
50083c	8901	Arm Rock Shaft Crank (back) Set Screw.
54132	8923	“ “ “ “ (front) with 448c and 453c.....
2117	8901	Arm Rock Shaft Crank (front) Pin.....
448c	8923	“ “ “ “ “ Set Screw
54105	8901	“ “ “ Flanged Bushing (front)
52045	8901	“ “ “ “ “ “ Oil Pad (braided cotton).....
453c	8901	Arm Rock Shaft Flanged Bushing (front) Set Screw.....
54006	8903	Arm Rotary Shaft.....
54081	8901	“ “ “ Bushing (front).....
52045	8901	“ “ “ “ “ Oil Pad (braided cotton).....
761E	8901	Arm Rotary Shaft Bushing (front) Set Screw.....
54007	8902	Arm Rotary Shaft Bushing (intermediate)
54089	—	“ “ “ “ “ “ 54007 with 42367 and 64508.....
64508	8902	Arm Rotary Shaft Bushing (intermediate) Oil Pad, long (braided cotton).....
42367	8901	Arm Rotary Shaft Bushing (intermediate) Oil Pad, short (braided cotton).....
422c	8901	Arm Rotary Shaft Bushing (intermediate) Set Screw (long).....
50084c	8901	Arm Rotary Shaft Bushing (intermediate) Set Screw (short).....
54008	8901	Arm Rotary Shaft Collar with two 1258c.
1258c	8901	“ “ “ “ Set Screw.....
54009	8902	“ “ “ Flanged Bushing.....
54090	—	“ “ “ “ “ 54009 with 42367 and 58039.....
58039	8902	Arm Rotary Shaft Flanged Bushing Oil Pad, long (braided cotton).....
42367	8901	Arm Rotary Shaft Flanged Bushing Oil Pad, short (braided cotton).....
159F	8901	Arm Rotary Shaft Flanged Bushing Screw
49013	8904	“ “ “ Front Bearing Oil Pad (braided cotton).....
144B	8901	Arm Rotary Shaft Screw.....
15196	8902	“ Side Cover (back).....

NO.	PLATE	NAME
286D	8904	Arm Side Cover (back) Thumb Screw....
54010	8904	“ “ “ (front).....
286D	8904	“ “ “ “ Thumb Screw....
54210	8924	Balance Wheel, 2 $\frac{5}{8}$ in. pulley, with two 430c.....
430c	8904	Balance Wheel Set Screw.....
54011	8903	Cloth Plate.....
1011F	8904	“ “ Screw (left).....
50473F	8904	“ “ “ (right).....
54012	8902	“ “ Slide (left).....
54013	—	Cloth Plate Slide (left) complete, Nos. 38419, 54012 and two 725J.....
38419	8904	Cloth Plate Slide (left) Spring.....
725J	8904	“ “ “ “ “ Screw....
54133	8925	“ “ “ (right).....
54134	—	Cloth Plate Slide (right) complete, Nos. 38419, 54133, 54209 and four 725J....
54209	8923	Cloth Plate Slide (right) Position Spring
725J	8904	“ “ “ “ “ “ Screw.....
38419	8904	Cloth Plate Slide (right) Spring.....
725J	8904	“ “ “ “ “ “ Screw....
54135	—	Cloth Plate complete, Nos. 54011, 54013 and 54134.....
54136	8926	Cloth Plate Thread Guard.....
1235D	8904	“ “ “ “ “ Screw....
54017	8902	Crank Connecting Rod with 6575, 54018, 54218, 54897, 57222 and two each 896E and 1057E.....
50069c	8904	Crank Connecting Rod Ball Screw Stud
1516E	8904	“ “ “ “ “ “ Nut.....
64268	8904	Crank Connecting Rod Ball Screw Stud Washer.....
*57222	—	Crank Connecting Rod Cap (lower).....
896E	8904	“ “ “ “ “ “ Screw
*54018	—	“ “ “ “ “ (upper).....
1057E	8904	“ “ “ “ “ “ Screw
54897	8904	“ “ “ Oil Cup.....
54218	8904	“ “ “ “ Pad (braided cotton).....
6575	8904	Crank Connecting Rod Oil Pad Stop Pin
54137	8926	Face Plate.....
142D	8923	“ “ Screw.....
54111	8902	Feed Connecting Rod with 1057E, 54112 and two 896E.....
*54112	—	Feed Connecting Rod Cap.....

NO.	PLATE	NAME
896E	8904	Feed Connecting Rod Cap Screw.....
1057E	8904	" " " Clamping Screw...
54138	8923	" " " Hinge Pin.....
21506	8904	" " " " " Collar with 457c.....
457c	8904	Feed Connecting Rod Hinge Pin Collar Set Screw.....
54139	8927	Feed Dog, for glove work.....
157J	8904	" " Screw.....
50429c	8904	" " Stop Screw.....
*54024	---	" Eccentric.....
*23729	---	" " Body.....
443c	8904	" " " Set Screw.....
7071	8904	" " Clamping Washer.....
217D	8904	" " " " " Screw...
61171	8904	" " Pressure Spring.....
21332	8904	" " " " " Cap.....
934J	8904	" " " " " Screw
54025	8906	Feed Eccentric (adjustable) complete, Nos. 217B, 934J, 1103c, 7071, 21332, 23729, 54024, 61171 and two 443c....
1103c	8904	Feed Regulating Screw.....
54019	8902	" (lower) Bar with 50429c and two 453c.....
54020	8902	Feed (lower) Bar Connection.....
57225	8904	" " " Hinge Pin.....
453c	8901	" " " " " Set Screw...
54026	8905	" " Rocking Frame with two 453c.....
54140	8925	Feed (lower) Rocking Frame Hinge Pin
57235	8906	" " " " " " "
		Bushing.....
453c	8901	Feed (lower) Rocking Frame Hinge Pin Bushing Set Screw.....
453c	8901	Feed (lower) Rocking Frame Hinge Pin Set Screw.....
54141	8928	Feed (upper) Bar, for glove work.....
54169	8928	" " " " binding and general work.....
1423D	8928	Feed (upper) Bar Cap Screw.....
54142	8928	" " " Connecting Bracket...
54143	8928	" " " " Link.....
1423D	8928	" " " " " Cap Screw.....
54144	8928	Feed (upper) Bell Crank.....
1423D	8928	" " " " Cap Screw.....
54145	8928	" " " " Connecting Link

NO.	PLATE	NAME
1423D	8928	Feed (upper) Bell Crank Connecting Link Cap Screw.....
54146	8928	Feed (upper) Bell Crank Connecting Stud with 889c.....
889c	8928	Feed (upper) Bell Crank Connecting Stud Set Screw.....
54147	8928	Feed (upper) Connection.....
54148	8928	" " " " Pin.....
453c	8901	" " " " Set Screw..
24479	8928	" " " Slide Bar.....
50200c	8928	" " " " " Set Screw.....
1194c	8928	Feed (upper) Lifting Regulating Screw
1749c	8928	" " " " "
		Nut.....
9525	8928	Feed (upper) Lifting Regulating Screw Nut Washer.....
54149	8928	Feed (upper) Lifting Regulator with 50200c.....
54150	8928	Feed (upper) Lifting Regulator Connect- ing Link.....
1423D	8928	Feed (upper) Lifting Regulator Connect- ing Link Cap Screw.....
50200c	8928	Feed (upper) Lifting Regulator Set Screw
54151	8929	" " " " Shaft
54152	8928	" " " " "
		Crank with two 50200c.....
50200c	8928	Feed (upper) Lifting Regulator Shaft Crank Set Screw.....
50950c	8929	Feed (upper) Regulating Screw Stud
51552c	8929	" " " " "
		Nut.....
39026	8929	Feed (upper) Regulating Screw Stud Washer.....
54155	8925	(Feed upper) Rock Shaft.....
65537	8929	" " " " Collar with two 465c.....
465c	8909	Feed (upper) Rock Shaft Collar Set Screw
54156	8929	" " " " Crank (back) with two 50200c.....
50200c	8928	Feed (upper) Rock Shaft Crank (back) Set Screw.....
52595	8929	Feed (upper) Rock Shaft Crank (front) with 1057E.....
1057E	8904	Feed (upper) Rock Shaft Crank (front) Clamping Screw.....
54157	8925	Feed (upper) Rock Shaft Pitman.....

From the library of: Daqing Medical Corp.

NO.	PLATE	NAME
41F	8929	Feed (upper) Rock Shaft Pitman Hinge Screw.....
1520J	8907	Feed (upper) Rock Shaft Pitman Hinge Screw Nut.....
54153	8925	Feed (upper) Rocking Frame with two 453c.....
453c	8901	Feed (upper) Rocking Frame Set Screw..
54154	8929	" " " " Slide Block
54158	8929	Feeding Foot Hinge Pin for 54161, 54172 and 54213.....
54159	—	Feeding Foot Plate for 54161.....
54170	—	" " " " 54172.....
54212	—	" " " " 54213.....
54160	—	" " Shank for 54161 and 54213
54171	—	" " " " 54172.....
54161	8929	Feeding Foot (hinged) complete, for glove work, Nos. 54158 to 54160.....
54172	8929	Feeding Foot (hinged) complete, for binding and general work, Nos. 54158, 54170 and 54171.....
54213	8929	Feeding Foot (hinged) raised toe, complete, for glove work, Nos. 54158, 54160 and 54212.....
203D	8929	Feeding Foot Screw.....
57255	8908	Lifting Presser Bar with 25303.....
25303	8907	" " " Ball, size 1/4 in.....
61046	8908	" " " Bushing (lower).....
1133E	8907	" " " " " S e t Screw.....
54162	8929	Lifting Presser Bar Bushing (upper).....
1133E	8907	" " " " " " S e t Screw.....
54039	8908	Lifting Presser Bar Guide Bracket with 453c, 640J and 1963.....
640J	8907	Lifting Presser Bar Guide Bracket Adjusting Screw.....
11173	8908	Lifting Presser Bar Guide Bracket Guide
447c	8908	" " " " " " " " Set Screw.....
1963	8908	Lifting Presser Bar Guide Bracket Roller and Stud.....
453c	8901	Lifting Presser Bar Guide Bracket Set Screw.....
54163	8929	Lifting Presser Bar Lifter.....
1872	8908	" " " " Roller and Stud
54164	8930	" " " Lifting Bracket with 462c and 1872.....

NO.	PLATE	NAME
54165	8925	Lifting Presser Bar Lifting Lever.....
54197	8930	" " " " " Connect- ing Stud.....
462c	8930	Lifting Presser Bar Lifting Lever Con- necting Stud Set Screw.....
54103	8905	Lifting Presser Bar Lifting Lever Exten- sion.....
161D	8908	Lifting Presser Bar Lifting Lever Exten- sion Screw (left).....
176D	8907	Lifting Presser Bar Lifting Lever Exten- sion Screw (right).....
802D	8908	Lifting Presser Bar Lifting Lever Hinge Screw.....
54040	8905	Lifting Presser Bar Spring (flat).....
38468	8908	" " " " Stud.....
54166	8930	" " Foot, for glove work.....
54173	8930	" " " " binding.....
54207	8930	" " " (small needle hole) for light glove or similar work.....
54214	8930	Lifting Presser Foot (raised toe) for glove work.....
190D	8908	Lifting Presser Foot Screw.....
46335	8930	Looper with 590D and 38393.....
53131	—	" 46335 with 229D and 5266F.....
54027	8906	" Carrier with two 171F.....
171F	8906	" " Adjusting Screw.....
54028	8906	" " Connection.....
50607J	8906	" " " Oil Plug Screw
54029	8906	" " " Shaft.....
54030	8906	" " " " Bushing
50608J	8906	" " " " " " Cap Screw.....
446c	8901	Looper Carrier Connection Shaft Bushing Set Screw.....
49013	8904	Looper Carrier Connection Shaft Oil Pad (braided cotton).....
54031	8906	Looper Carrier Driver with 54032 and four 391D.....
*54032	—	Looper Carrier Driver Cap.....
391D	8906	" " " " " Screw.....
54033	8907	" Driving Shaft and Feed Lifting Eccentric with 227D and 64315.....
*54034	8905	Looper Driving Shaft and Feed Lifting Eccentric Bracket with 761E.....
54080	8906	Looper Driving Shaft and Feed Lifting Eccentric Bracket Bushing.....

from the Library of Diamond Speed Corp.



NO.	PLATE	NAME	
50133c	8909	Tension (upper thread)	Screw Stud.....
52975	8909	" " "	Spring.....
13915	8909	" " "	" Bushing..
17547	8909	" " "	Thread Guide...
38225	8909	Thread (under)	Eyelet (back).....
190D	8908	" " "	" Screw.....
38284	8909	" " "	" (front).....
64351	8909	" " "	Nipper Cam with 465c...
465c	8909	" " "	" Set Screw...
38210	8909	" " "	Spring (lower)...
38211	8909	" " "	" (upper)...
46247	8909	" " "	" " Stop
176D	8907	" " "	" Screw.....
38475	8910	" " "	Take-up with 465c.....
465c	8909	" " "	" Set Screw.....
38478	8910	" " "	Staple with two
		each 590D and 38481.....	
54049	8905	Thread (under)	Take-up Staple Bracket
		with 460c.....	
965D	8910	Thread (under)	Take-up Staple Bracket
		Screw.....	
46041	8909	Thread (under)	Take-up Staple Spring
190D	8908	" " "	" " "
		Screw.....	
38481	8910	Thread (under)	Take-up Staple Thread
		Guard.....	
590D	8907	Thread (under)	Take-up Staple Thread
		Guard Screw.....	
38482	8910	Thread (under)	Take-up Stripper.....
207D	8910	" " "	" " Screw.
64355	8910	" " "	Thread Guard
		(brass).....	
64356	8910	Thread (under)	Take-up Thread Guard
		Steady Pin.....	
460c	8910	Thread (under)	Take-up Thread Guard
		Steady Pin Set Screw.....	
54050	8930	Thread (upper)	Controller.....
207D	8910	" " "	" Screw.....
38484	8930	" " "	Eyelet.....
190D	8908	" " "	" Screw.....
54193	8923	" " "	Take-up.....
54194	8923	" " "	" Plate.....
54716	8922	" " "	" " Spring
1449D	8922	" " "	" " "
		Screw.....	
54195	—	Thread (upper)	Take-up complete, Nos.
		1449D, 54193, 54194 and 54716.....	

NO.	PLATE	NAME	
219F	8907	Thread (upper)	Take-up Set Screw.....
54168	8927	Throat Plate (large needle hole)	for 54139
54215	8927	" " (small needle hole)	for 54139,
		for glove and similar work.....	
742F	8910	Throat Plate Screw.....	

SINGER Needles should be used  
in SINGER Machines.  
These Needles and their Containers  
are marked with the  
Company's Trade Mark "SIMANCO." 1

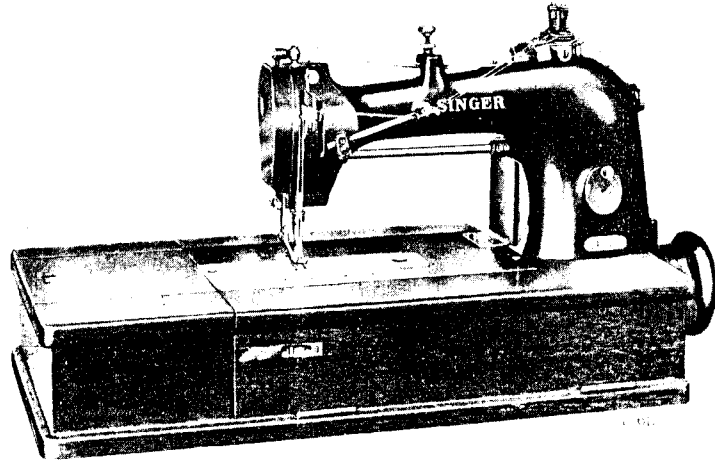
Needles in Containers marked  
"FOR SINGER MACHINES"  
are NOT **SINGER** made needles. 2

From the library of: Diamond Needle Corp



**LIST OF PARTS COMPLETE**

**FOR**



**MACHINE No. 147-23**

**FOR GENERAL WORK IN FABRICS AND LIGHT LEATHER. TWO NEEDLES, TWO LOOPERS. GAUGES  $\frac{3}{32}$  TO  $\frac{3}{8}$  INCH. ALTERNATING PRESSERS, INDEPENDENT UPPER AND UNDER FEEDS. THIS MACHINE WILL TAKE THE PLACE OF 62-47.**

NO.	PLATE	NAME
*54130	---	Arm, upper and lower (solid) with 948d and 54034.....
42366	8901	Arm Oil Pad (braided cotton) for oiling Arm Rock Shaft Front Bearing.....
56006	8901	Arm Oil Pad (braided cotton) for oiling Arm Rock Shaft Intermediate Bearing.....
11119	8901	Arm Oil Tube with 29599, for oiling 64321.....
40217	8923	" " " " " " " " 54147.....
29599	8901	" " " Packing (felt).....
54002	8902	" Rock Shaft.....
64386	8901	" " " Bushing (back).....
446c	8901	" " " " " Set Screw.....
64388	8901	" " " " (intermediate).....
423c	8901	" " " " Set Screw.....

NO.	PLATE	NAME
52045	8901	Arm Rock Shaft Bushing Oil Pad (braided cotton).....
54004	8901	Arm Rock Shaft Collar with two 453c.....
453c	8901	" " " " Set Screw.....
54005	8901	" " " Crank (back) with two 50083c.....
50083c	8901	Arm Rock Shaft Crank (back) Set Screw.....
54132	8923	" " " " (front) with 448c and 453c.....
2117	8901	Arm Rock Shaft Crank (front) Pin.....
448c	8923	" " " " " Set Screw.....
54105	8901	" " " Flanged Bushing (front).....
52045	8901	" " " " " " " " Oil Pad (braided cotton).....
453c	8901	Arm Rock Shaft Flanged Bushing (front) Set Screw.....
54006	8903	Arm Rotary Shaft.....
54081	8901	" " " Bushing (front).....
52045	8901	" " " " " Oil Pad (braided cotton).....
761E	8901	Arm Rotary Shaft Bushing (front) Set Screw.....
54007	8902	Arm Rotary Shaft Bushing (intermediate).....
54089	---	" " " " " " " " 54007 with 42367 and 64508.....
64508	8902	Arm Rotary Shaft Bushing (intermediate) Oil Pad, long (braided cotton).....
42367	8901	Arm Rotary Shaft Bushing (intermediate) Oil Pad, short (braided cotton).....
422c	8901	Arm Rotary Shaft Bushing (intermediate) Set Screw (long).....
50084c	8901	Arm Rotary Shaft Bushing (intermediate) Set Screw (short).....
54008	8901	Arm Rotary Shaft Collar with two 1258c.....
1258c	8901	" " " " " Set Screw.....
54009	8902	" " " Flanged Bushing.....
54090	---	" " " " " " 54009 with 42367 and 58039.....
58039	8902	Arm Rotary Shaft Flanged Bushing Oil Pad, long (braided cotton).....
42367	8901	Arm Rotary Shaft Flanged Bushing Oil Pad, short (braided cotton).....
159F	8901	Arm Rotary Shaft Flanged Bushing Screw.....
49013	8904	" " " Front Bearing Oil Pad (braided cotton).....
144D	8901	Arm Rotary Shaft Screw.....
15196	8902	" Side Cover (back).....

NO.	PLATE	NAME
286D	8904	Arm Side Cover (back) Thumb Screw...
54010	8904	" " " (front).....
286D	8904	" " " " Thumb Screw...
54210	8924	Balance Wheel, 2 $\frac{5}{8}$ in. pulley, with two 430c.....
430c	8904	Balance Wheel Set Screw.....
54011	8903	Cloth Plate.....
1011F	8904	" " Screw (left).....
50473F	8904	" " " (right).....
54012	8902	" " Slide (left).....
54013	—	Cloth Plate Slide (left) complete, Nos. 38419, 54012 and two 725J.....
38419	8904	Cloth Plate Slide (left) Spring.....
725J	8904	" " " " " Screw.....
54133	8925	" " " (right) for 54134.....
54134	—	Cloth Plate Slide (right) complete for 54135, Nos. 38419, 54133, 54209 and four 725J.....
54209	8923	Cloth Plate Slide (right) Position Spring
725J	8904	" " " " " " "
		Screw.....
54055	8924	Cloth Plate Slide (right) for 54056.....
54056	—	Cloth Plate Slide (right) complete for 54059, Nos. 38419, 54055 and two 725J
54057	8924	Cloth Plate Slide (right) for 54058.....
54058	—	Cloth Plate Slide (right) complete for 54060, Nos. 38419, 54057 and two 725J
1602E	8922	Cloth Plate Slide (right) Bushing.....
38419	8904	" " " " Spring.....
725J	8904	" " " " " Screw...
54135	—	Cloth Plate complete, for $\frac{3}{8}$ in. to $\frac{1}{2}$ in. gauges, Nos. 54011, 54013 and 54134..
54059	—	Cloth Plate complete, for $\frac{1}{8}$ in. to $\frac{1}{4}$ in. gauges, Nos. 54011, 54013 and 54056..
54060	—	Cloth Plate complete, for $\frac{3}{8}$ in. to $\frac{3}{8}$ in. gauges, Nos. 54011, 54013 and 54058..
54136	8926	Cloth Plate Thread Guard.....
1235D	8904	" " " " Screw.....
54017	8902	Crank Connecting Rod with 6575, 54018, 54218, 54897, 57222 and two each 896E and 1057E.....
50069C	8904	Crank Connecting Rod Ball Screw Stud
1516E	8904	" " " " " "
		Nut.....
64268	8904	Crank Connecting Rod Ball Screw Stud Washer.....
*57222	—	Crank Connecting Rod Cap (lower).....

NO.	PLATE	NAME
896E	8904	Crank Connecting Rod Cap (lower) Screw
*54018	—	" " " " (upper).....
1057E	8904	" " " " Screw
54897	8904	" " " Oil Cup.....
54218	8904	" " " " Pad (braided cotton).....
6575	8904	Crank Connecting Rod Oil Pad Stop Pin
54137	8926	Face Plate.....
142D	8923	" " Screw.....
54111	8902	Feed Connecting Rod with 1057E, 54112 and two 896E.....
*54112	—	Feed Connecting Rod Cap.....
896E	8904	" " " " Screw.....
1057E	8904	" " " Clamping Screw...
54138	8923	" " " Hinge Pin.....
21506	8904	" " " " " " Collar with 457c.....
457c	8904	Feed Connecting Rod Hinge Pin Collar Set Screw.....
52534	8927	Feed Dog.....
54221	8954	" " (spiked teeth) for binding blankets and similar work.....
157J	8904	Feed Dog Screw.....
50429c	8904	" " Stop Screw.....
*54024	—	" Eccentric.....
*23729	—	" " Body.....
443c	8904	" " " Set Screw.....
7071	8904	" " Clamping Washer.....
217D	8904	" " " " Screw..
61171	8904	" " Pressure Spring.....
21332	8904	" " " " Cap.....
934J	8904	" " " " " Screw
54025	8906	Feed Eccentric (adjustable) complete, Nos. 217D, 934J, 1103c, 7071, 21332, 23729, 54024, 61171 and two 443c....
1103c	8904	Feed Regulating Screw.....
54019	8902	" (lower) Bar with 50429c and two 453c.....
54020	8902	Feed (lower) Bar Connection.....
57225	8904	" " " Hinge Pin.....
453c	8901	" " " " " Set Screw...
54026	8905	" " Rocking Frame with two 453c.....
54140	8925	Feed (lower) Rocking Frame Hinge Pin
57235	8906	" " " " " " "
		Bushing.....

NO.	PLATE	NAME
453c	8901	Feed (lower) Rocking Frame Hinge Pin Bushing Set Screw.....
453c	8901	Feed (lower) Rocking Frame Hinge Pin Set Screw.....
54169	8928	Feed (upper) Bar, for binding and general work.....
1423b	8928	Feed (upper) Bar Cap Screw.....
54142	8928	" " " " Connecting Bracket...
54143	8928	" " " " Link.....
1423b	8928	" " " " " Cap Screw.....
54144	8928	Feed (upper) Bell Crank.....
1423b	8928	" " " " Cap Screw.....
54145	8928	" " " " Connecting Link.....
1423b	8928	" " " " " Cap Screw.....
54146	8928	Feed (upper) Bell Crank Connecting Stud with 889c.....
889c	8928	Feed (upper) Bell Crank Connecting Stud Set Screw.....
54147	8928	Feed (upper) Connection.....
54148	8928	" " " " Pin.....
453c	8901	" " " " Set Screw..
24479	8928	" " " " Slide Bar.....
50200c	8928	" " " " " S e t Screw.....
1194c	8928	Feed (upper) Lifting Regulating Screw.....
1749c	8928	" " " " " Nut.....
9525	8928	Feed (upper) Lifting Regulating Screw Nut Washer.....
54149	8928	Feed (upper) Lifting Regulator with 50200c.....
54150	8928	Feed (upper) Lifting Regulator Connecting Link.....
1423b	8928	Feed (upper) Lifting Regulator Connecting Link Cap Screw.....
50200c	8928	Feed (upper) Lifting Regulator Set Screw.....
54151	8929	" " " " " S h a f t.....
54152	8928	" " " " " Crank with two 50200c.....
50200c	8928	Feed (upper) Lifting Regulator Shaft Crank Set Screw.....
50950c	8929	Feed (upper) Regulating Screw Stud.....
51552c	8929	" " " " " Nut.....

NO.	PLATE	NAME
39026	8929	Feed (upper) Regulating Screw Stud Washer.....
54155	8925	Feed (upper) Rock Shaft.....
65537	8929	" " " " Collar with two 465c.....
465c	8909	Feed (upper) Rock Shaft Collar Set Screw.....
54156	8929	Feed (upper) Rock Shaft Crank (back) with two 50200c.....
50200c	8928	Feed (upper) Rock Shaft Crank (back) Set Screw.....
52595	8929	Feed (upper) Rock Shaft Crank (front) with 1057E.....
1057E	8904	Feed (upper) Rock Shaft Crank (front) Clamping Screw.....
54157	8925	Feed (upper) Rock Shaft Pitman.....
41F	8929	" " " " " H i n g e Screw.....
1520J	8907	Feed (upper) Rock Shaft Pitman Hinge Screw Nut.....
54153	8925	Feed (upper) Rocking Frame with two 453c.....
453c	8901	Feed (upper) Rocking Frame Set Screw..
54154	8929	" " " " " S l i d e B l o c k.....
52596	8929	Feeding Foot.....
54158	8929	" " Hinge Pin.....
54222	----	" " Plate.....
54223	----	" " Shank.....
54224	8954	Feeding Foot (hinged) complete, for binding blankets and similar work, Nos. 54158, 54222 and 54223.....
203D	8929	Feeding Foot Screw.....
57255	8908	Lifting Presser Bar with 25303.....
25303	8907	" " " " Ball, size 1/4 in.....
61046	8908	" " " " Bushing (lower).....
1133E	8907	" " " " " S e t Screw.....
54162	8929	Lifting Presser Bar Bushing (upper).....
1133E	8907	" " " " " S e t Screw.....
54039	8908	Lifting Presser Bar Guide Bracket with 453c, 640J and 1963.....
640J	8907	Lifting Presser Bar Guide Bracket Adjusting Screw.....
11173	8908	Lifting Presser Bar Guide Bracket Guide.....
447c	8908	" " " " " S e t S c r e w.....

 From the Library of: <http://www.industrydocuments.ucsf.edu/docs/14723>

NO.	PLATE	NAME
1963	8908	Lifting Presser Bar Guide Bracket Roller and Stud.....
453c	8901	Lifting Presser Bar Guide Bracket Set Screw.....
54163	8929	Lifting Presser Bar Lifter.....
1872	8908	“ “ “ “ Roller and Stud.....
54164	8930	“ “ “ “ Lifting Bracket with 462c and 1872.....
54165	8925	Lifting Presser Bar Lifting Lever.....
54197	8930	“ “ “ “ “ Connecting Stud.....
462c	8930	Lifting Presser Bar Lifting Lever Connecting Stud Set Screw.....
54103	8905	Lifting Presser Bar Lifting Lever Extension.....
161D	8908	Lifting Presser Bar Lifting Lever Extension Screw (left).....
176D	8907	Lifting Presser Bar Lifting Lever Extension Screw (right).....
802D	8908	Lifting Presser Bar Lifting Lever Hinge Screw.....
54040	8905	Lifting Presser Bar Spring (flat).....
38468	8908	“ “ “ “ Stud.....
52535	8930	“ “ Foot.....
54225	8954	“ “ “ for binding blankets and similar work.....
190D	8908	Lifting Presser Foot Screw.....
38493	8922	Looper (back) with 590D and 38494.....
NOTE. When ordering No. 38493, state gauge of machine for which required.		
1147c	8922	Looper (back) Set Screw.....
38494	8922	“ “ Thread Guard (double)....
590D	8907	“ “ “ “ Screw.....
38495	8922	“ (front).....
NOTE. When ordering No. 38495, state gauge of machine for which required.		
1120c	8907	Looper (front) Set Screw.....
54027	8906	“ Carrier with two 171E.....
171E	8906	“ “ Adjusting Screw.....
54028	8906	“ “ Connection.....
50607J	8906	“ “ “ Oil Plug Screw.....
54029	8906	“ “ “ Shaft.....
54030	8906	“ “ “ “ Bushing.....
50608J	8906	“ “ “ “ “ Cap Screw.....

NO.	PLATE	NAME
446c	8901	Looper Carrier Connection Shaft Bushing Set Screw.....
49013	8904	Looper Carrier Connection Shaft Oil Pad (braided cotton).....
54031	8906	Looper Carrier Driver with 54032 and four 391D.....
*54032	-----	Looper Carrier Driver Cap.....
391D	8906	“ “ “ “ Screw.....
54033	8907	“ Driving Shaft and Feed Lifting Eccentric with 227D and two 64315....
*54034	8905	Looper Driving Shaft and Feed Lifting Eccentric Bracket with 761E.....
54080	8906	Looper Driving Shaft and Feed Lifting Eccentric Bracket Bushing.....
761E	8901	Looper Driving Shaft and Feed Lifting Eccentric Bracket Bushing Set Screw..
948D	8906	Looper Driving Shaft and Feed Lifting Eccentric Bracket Screw.....
64315	8907	Looper Driving Shaft and Feed Lifting Eccentric Oil Hole Plug.....
227D	8907	Looper Driving Shaft and Feed Lifting Eccentric Oil Hole Screw.....
40326	8907	Looper Driving Shaft and Feed Lifting Eccentric Oil Pad (braided cotton)....
640D	8907	Looper Driving Shaft and Feed Lifting Eccentric Screw.....
54061	8922	Looper Holder with 1120c and 1147c....
704J	8907	“ “ Screw.....
64319	8922	Needle Bar (hollow).....
54062	-----	Needle Bar complete, for $\frac{3}{8}$ in. to $\frac{1}{4}$ in. gauges, Nos. 54064, 54065 and 64319..
54063	-----	Needle Bar complete, for $\frac{3}{8}$ in. to $\frac{3}{8}$ in. gauges, Nos. 54064, 54066 and 64319..
38456	8907	Needle Bar Bushing (lower).....
1133E	8907	“ “ “ “ Set Screw....
64320	8907	“ “ “ (upper).....
1133E	8907	“ “ “ “ Set Screw....
64321	8907	“ “ Connecting Link.....
52992	8907	“ “ “ “ Hinge Stud.....
1520E	8907	“ “ “ “ “ Nut.....
64323	8907	Needle Bar Connecting Stud with 219F and two 399E.....
399E	8907	Needle Bar Connecting Stud Clamping Screw.....
54064	8922	Needle Clamp with two 1498F.....
54065	8922	“ “ Thread Guard for 54062...

NO.	PLATE	NAME
54066	8922	Needle Clamp Thread Guard for 54063...
54067	8922	" Guard, for $\frac{3}{32}$ in. to $\frac{5}{32}$ in. gauges.
54068	8922	" " " $\frac{1}{16}$ in. to $\frac{3}{32}$ in. gauges.
54069	8922	" " " $\frac{1}{16}$ in. to $\frac{3}{8}$ in. gauges.
54038	8907	" " Holder.....
	176D 8907	" " Screw.....
	219F 8907	" " Screw.....
	1498F 8922	" Set Screw.....
54108	-----	Oil Tube.....
54109	-----	" " Bracket.....
49092	8908	" " Packing (felt).....
54110	8908	Oil Tube complete, for oiling Crank Connecting Rod (upper bearing) Nos. 49092, 54108 and 54109.....
	574J 8908	Pressure Regulating Thumb Screw.....
	1539J 8908	" " " " Lock Nut.....
64336	8908	Slack Thread Controller.....
46035	8908	" " " Clamp.....
	190D 8908	" " " Screw....
64337	8922	" " Regulator.....
54042	8908	" " " Holder with 175E and 50150c.....
	175E 8908	Slack Thread Regulator Holder Clamping Screw.....
54043	8908	Slack Thread Regulator Holder Shaft
24292	8908	" " " " " Collar with 1019c.....
	1019c 8908	Slack Thread Regulator Holder Shaft Collar Set Screw.....
54044	8908	Slack Thread Regulator Holder Shaft Crank (forked) with 1253c.....
1253c	8908	Slack Thread Regulator Holder Shaft Crank Set Screw.....
50150c	8908	Slack Thread Regulator Set Screw.....
2102	8909	Tension (under thread) Disc.....
1560c	8909	" " " Regulating Thumb Nut.....
50148c	8909	Tension (under thread) Screw Stud.....
124687	-----	" " " " " 50148c with 1560c.....
42337	8909	Tension (under thread) Spring.....
13915	8909	" " " " Bushing..
17547	8909	" " " Thread Guide....
54070	8931	" (upper thread) Bracket.....
	376D 8909	" " " Screw....
	2102 8909	" " " Disc.....

NO.	PLATE	NAME
1560c	8909	Tension (upper thread) Regulating Thumb Nut.....
32572	8909	Tension (upper thread) Releasing Disc...
54988	8909	" " " " Pin....
54071	8922	" " " " Shaft
54047	8909	" " " " " Crank with 624c.....
54048	8909	Tension (upper thread) Releasing Shaft Crank Link.....
	624c 8909	Tension (upper thread) Releasing Shaft Crank Set Screw.....
54990	8909	Tension (upper thread) Releasing Shaft Spring.....
	316F 8909	Tension (upper thread) Releasing Shaft Stop Screw.....
	1547J 8909	Tension (upper thread) Releasing Shaft Stop Screw Nut.....
50133c	8909	Tension (upper thread) Screw Stud.....
52975	8909	" " " Spring.....
13915	8909	" " " " Bushing..
17547	8909	" " " Thread Guide....
54204	8931	Thread Lubricating Oil Cup.....
57629	8931	" " " " Pad (felt)....
54205	8931	" " " " Thread Guide
	217J 8904	" " " " " Screw.....
54206	-----	Thread Lubricating Oil Cup complete, Nos. 217J, 54204, 54205 and 57629....
38225	8909	Thread (under) Eyelet (back).....
	190D 8908	" " " " Screw.....
54072	8931	" " " (front).....
64351	8909	" " " Nipper Cam with 465c...
	465c 8909	" " " " Set Screw...
38210	8909	" " " Spring (lower)...
38211	8909	" " " " (upper)...
46247	8909	" " " " " Stop
	176D 8907	" " " " Screw....
38475	8910	" " " Take-up with 465c.....
	465c 8909	" " " Set Screw.....
46047	8931	" " " Staple.....
54049	8905	" " " " Bracket with 460c.....
	965D 8910	Thread (under) Take-up Staple Bracket Screw.....
46041	8909	Thread (under) Take-up Staple Spring
	190D 8908	" " " " " Screw.....

NO.	PLATE	NAME
38482	8910	Thread (under) Take-up Stripper.....
207D	8910	“ “ “ “ Screw..
64355	8910	“ “ “ Thread Guard (brass).....
64356	8910	Thread (under) Take-up Thread Guard Steady Pin.....
460C	8910	Thread (under) Take-up Thread Guard Steady Pin Set Screw.....
64357	8931	Thread (upper) Controller.....
207D	8910	“ “ “ “ Screw.....
46009	8931	“ “ Eyelet.....
190D	8908	“ “ “ “ Screw.....
54094	8922	“ “ Take-up.....
54095	8922	“ “ “ “ Plate.....
54716	8922	“ “ “ “ Spring....
1449D	8922	“ “ “ “ “ “ Screw
54096	---	Thread (upper) Take-up complete, Nos. 1449D, 54094, 54095 and 54716.....
219F	8907	Thread (upper) Take-up Set Screw.....
52542	8927	Throat Plate for 52534.....
54226	8954	“ “ “ “ 54221.....
742F	8910	“ “ “ “ Screw.....

## IRON BASE

NO.	PLATE	NAME
54091	8939	Machine Base with three each 599E, 6055 and four each 948E and 57285...
599E	8940	Machine Bolt with 1524E.....
1524E	8940	“ “ Nut.....
6055	8940	“ “ “ “ Washer.....
57285	8940	“ “ Cushion (felt).....
948E	8940	“ “ Screw, to fasten machine to base

## ACCESSORIES

NO.	PLATE	NAME
120344	8941	Oiler (copper plated) with 120345.....
120345	8911	“ Spout, 5 in. long.....
26026	8941	Screw Driver (large).....
26485	8941	“ “ (small).....
38487	8911	Threading Wire.....
120341	8911	Tweezers (curved).....
8908	8941	Wrench for 1520.....
19221	8941	“ “ 1516.....
4822	8941	“ “ 1547.....

## BELT GUARD

NO.	PLATE	NAME
54052	8939	Belt Guard with 453C.....
54053	8940	“ “ Bracket.....
27347	8940	“ “ Hinge Pin.....
57440	8940	“ “ “ “ Collar with 457C..
457C	8904	“ “ “ “ “ “ Set Screw..
453C	8901	“ “ Set Screw.....
430C	8904	“ “ Stop Screw.....
1520E	8907	“ “ “ “ Nut.....
54054	---	Belt Guard complete, Nos. 430C, 1520E, 27347, 54052, 54053, 57440 and wood screw 1¼ in. No. 10.....

## EDGE GUIDE (Roller)

FOR GLOVE WORK  
FOR 147-2 MACHINE

NO.	PLATE	NAME
226261	8942	Edge Guide with 201849.....
226259	8942	“ “ Bed with 226264.....
226262	8942	“ “ Lever.....
226264	---	“ “ “ Cushion (leather).....
200297B	---	“ “ “ Hinge Screw.....
201836	---	“ “ Roller.....
201849	8942	“ “ “ 201836 with 206521...
206521	---	“ “ “ Stud.....
226263	---	“ “ Spring.....
120421	8942	Edge Guide (roller) complete, Nos. 200297B, 226259 and 226261 to 226263
50152D	8942	Edge Guide Screw.....

## FOOT LIFTER PARTS

NO.	PLATE	NAME
6439	---	Chain, 36 in. to 45 in., with 56864 and 56865.....

NOTE. When ordering No. 6439, give length required.

4879	8941	Chain Connecting Link.....
56864	8941	“ Hook (large).....
56865	8910	“ “ (small).....
126249	8939	Treadle.....
4882	8941	“ Shaft.....
126250	8941	“ Spring.....
126251	8939	“ Stand.....
126252	8939	Treadle complete, Nos. 4882, 126249 to 126251 and two wood screws 1 in. No. 16



## KNEE LIFTER PARTS

NO.	PLATE	NAME
37563	—	Chain, length 15 in., with 56864 and 56865
56864	8941	“ Hook (large).....
56865	8910	“ “ (small).....
2763	8903	Rock Shaft.....
12242	8903	“ “ Hanger with two wood screws 1 in. No. 10.....
6335	8903	Rock Shaft Knee Arm.....
6336	—	Rock Shaft Knee Arm complete, Nos. 2766, 2767 and 6335.....
2766	8903	Rock Shaft Knee Arm Hub with 356c... 356c 8910 “ “ “ “ “ Set Screw....
2767	8903	“ “ “ Plate with 356c..... 356c 8910 “ “ “ “ Set Screw.....
6337	8903	“ “ Lifting Bracket with two 356c
7125	8903	“ “ “ “ Hook..... 356c 8910 “ “ “ “ “ Set Screw
356c	8910	“ “ “ “ “ Set Screw....
2770	8903	“ “ Stop Dog with 356c..... 356c 8910 “ “ “ “ Set Screw.....
23767	8903	Rock Shaft complete, Nos. 2763, 2770, 6336, 6337, 7125 and two 12242.....

## BENCH STAND

NO.	PLATE	NAME
79611	—	Bench Stand with 5604, 9370, two 41538, three wood screws 1¼ in. No. 14, four 60656 and sixteen wood screws ⅝ in. No. 7.....
41538	—	Flush Bolt with Plate complete, Nos. 126247, 126248 and four brass wood screws ⅝ in. No. 4.....
126247	8952	Flush Bolt.....
126248	8952	“ “ Plate.....
60656	8952	Hinge.....
9370	8952	Slide Spring.....
5604	8952	“ “ Pin.....

## THREAD UNWINDER

FOR TWO SPOOLS  
FOR 147-2 MACHINE

NO.	PLATE	NAME
225395	7233	Spool Rest with 201018c.....
225388	7233	“ “ Rod.....

NO.	PLATE	NAME
200383c	8910	Spool Rest Rod Set Screw.....
201018c	8910	“ “ Set Screw.....
202490	7233	“ Stand with 200383c.....
225391	7233	Thread Guide.....
201696j	8910	“ “ Lock Nut.....
225392	7233	“ “ Rod with 208E and 225393
208E	8910	“ “ “ Screw.....
225393	8910	“ “ “ Washer.....
225396	7233	Thread Unwinder complete, Nos. 201696j, 202490, 225388, 225392, 225395, two 225391 and three wood screws ⅞ in. No. 13.....
27739	7234	Thread Cone (wood) for large cones.....
225390	7234	“ “ Holder, for inverted cones..

NOTE. Nos. 27739 and 225390 are used with,  
but not included in, 225396.

## THREAD UNWINDER

FOR FOUR SPOOLS  
FOR 147-23 MACHINE

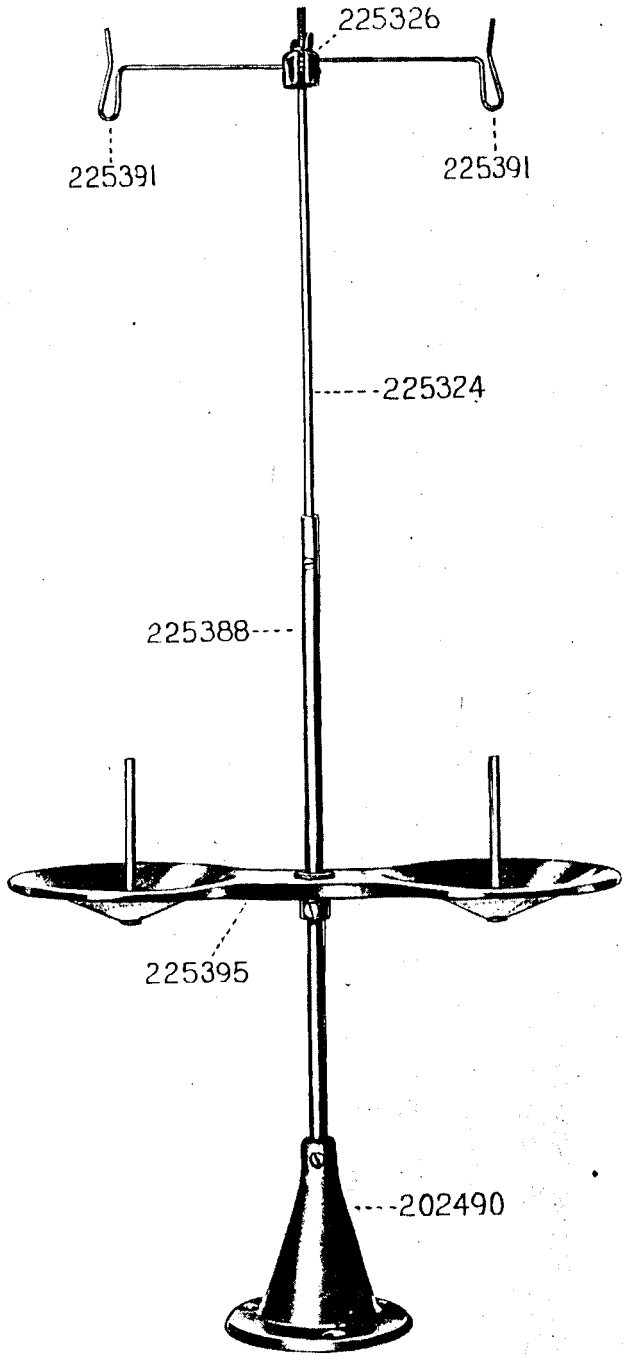
NO.	PLATE	NAME
225395	8953	Spool Rest (for two spools) with 201018c
225388	8953	“ “ Rod.....
200383c	8910	“ “ “ Set Screw.....
201018c	8910	“ “ Set Screw.....
202490	8953	“ Stand with 200383c.....
225391	8953	Thread Guide.....
201696j	8910	“ “ Lock Nut.....
225392	8953	“ “ Rod with 208E and 225393
208E	8910	“ “ “ Screw.....
225393	8910	“ “ “ Washer.....
225398	8953	Thread Unwinder complete, Nos. 201696j, 202490, 225388, 225392, two 225395, four 225391 and three wood screws ⅞ in. No. 13.....
27739	7234	Thread Cone (wood) for large cones.....
225390	7234	“ “ Holder, for inverted cones..

NOTE. Nos. 27739 and 225390 are used with,  
but not included in, 225398.

From the library of: Diamond Needle Corp

**PLATE 7233—ONE-FOURTH SIZE**

225396



225391

225326

225391

225324

225388

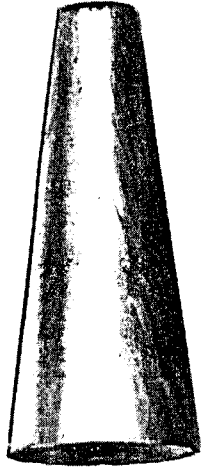
225395

202490



PLATE 7234—ONE-HALF SIZE

27739



225390

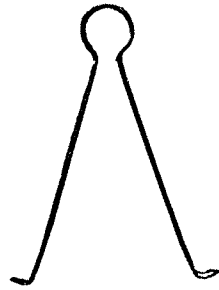


PLATE 8901—FULL SIZE

42366



56006



11119



29599



446



423



64386



64388



52045



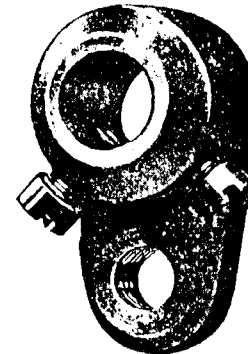
453



54004



54005



50083



2117



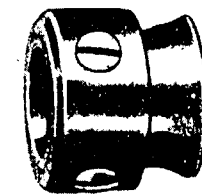
54105



54081



54008



42367



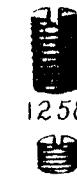
761



422



50084



159



144

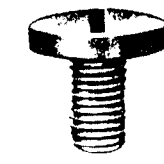
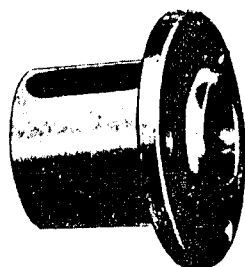
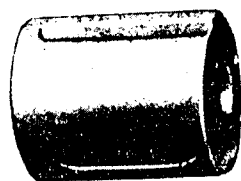


PLATE 8902—ONE-HALF SIZE

54002

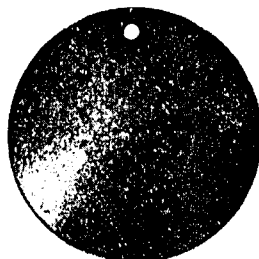
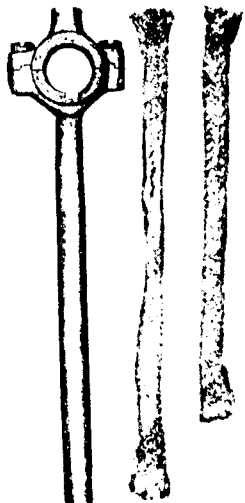
54007

54009

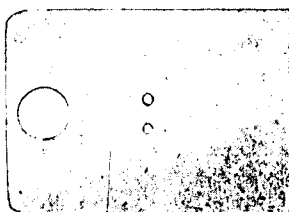


54017 64508 58039

15196

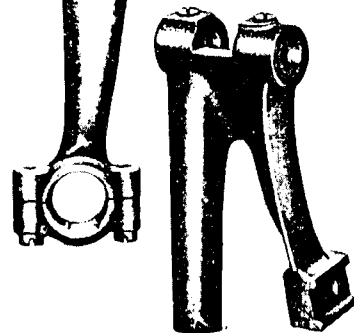


54012



54019

54111



54020

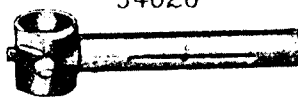
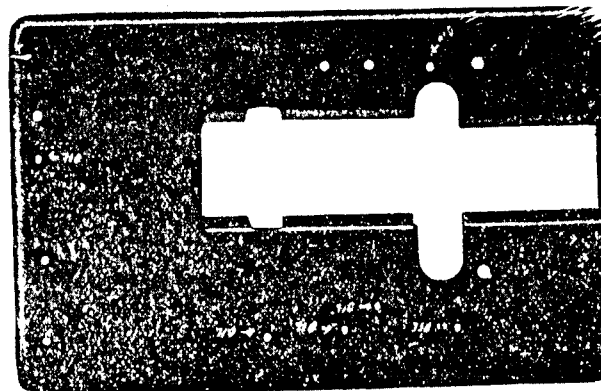


PLATE 8903—ONE-FOURTH SIZE

54011



54006

12242

12242

7125

6337

23767

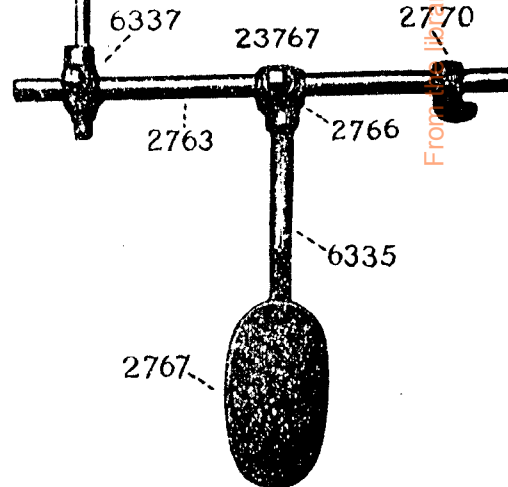
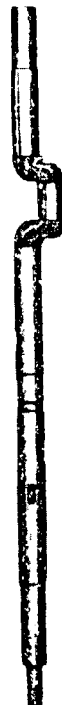
2770

2763

2766

6335

2767



Property of: Diamond Needle Corp

PLATE 8904—FULL SIZE

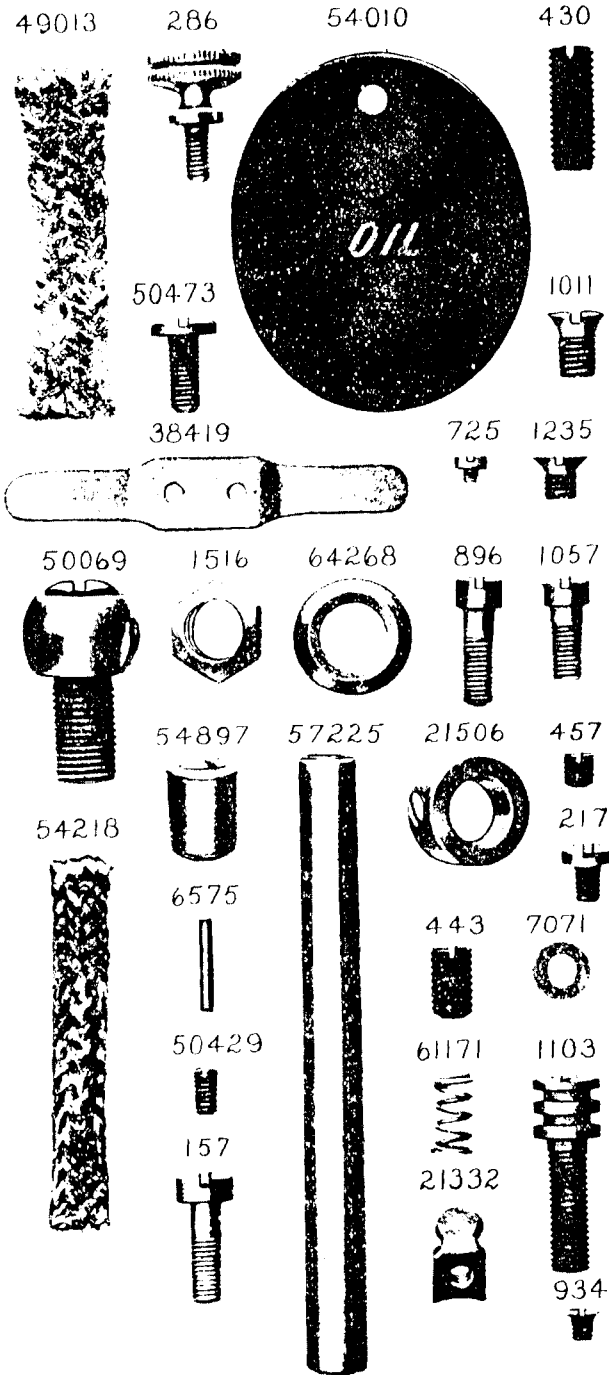
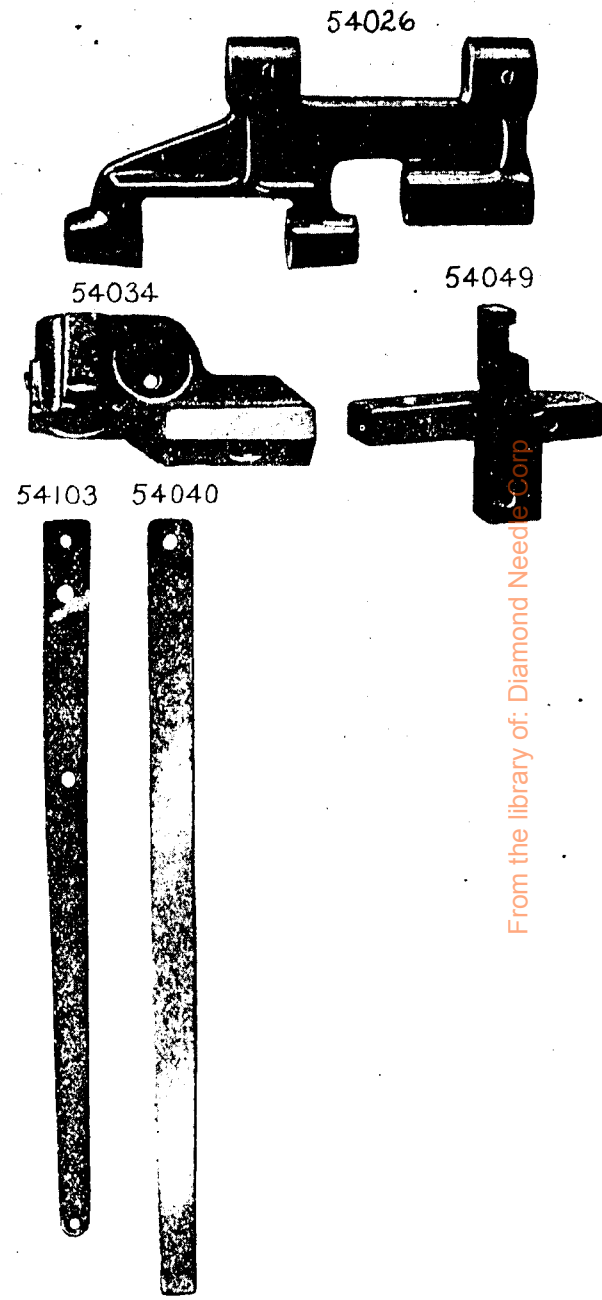


PLATE 8905—ONE-HALF SIZE



From the library of: Diamond Needle Corp.

PLATE 8906—FULL SIZE

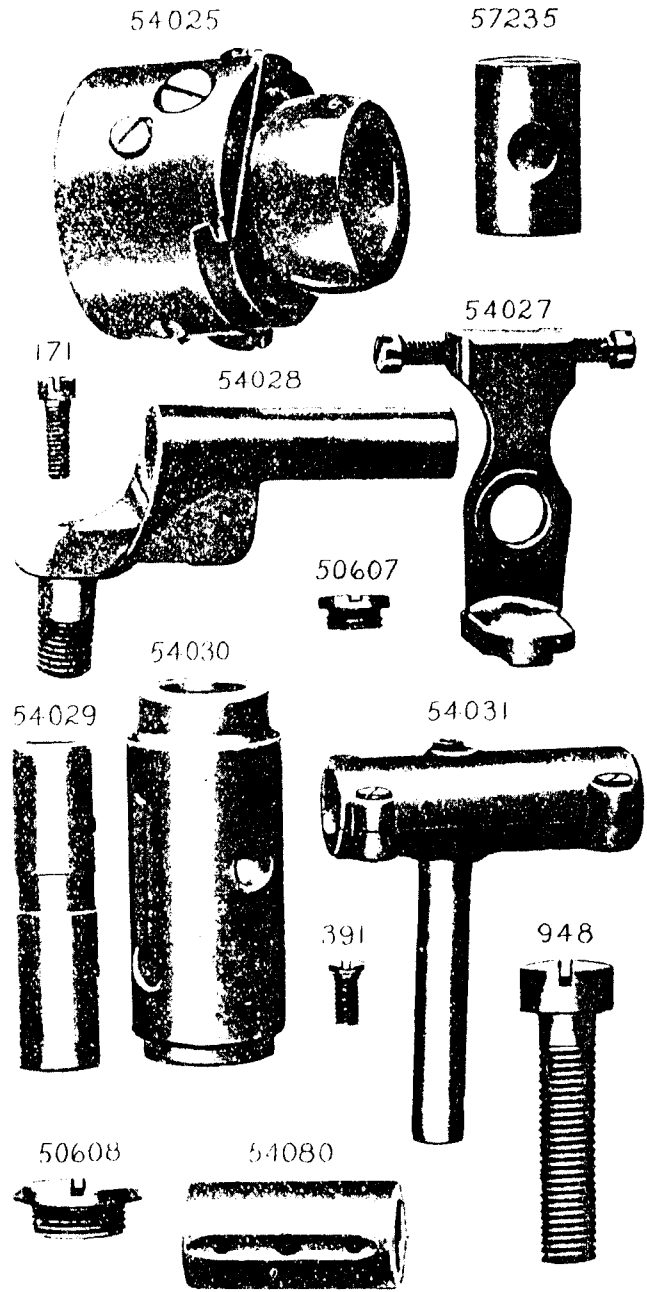


PLATE 8907—FULL SIZE



PLATE 8908—FULL SIZE

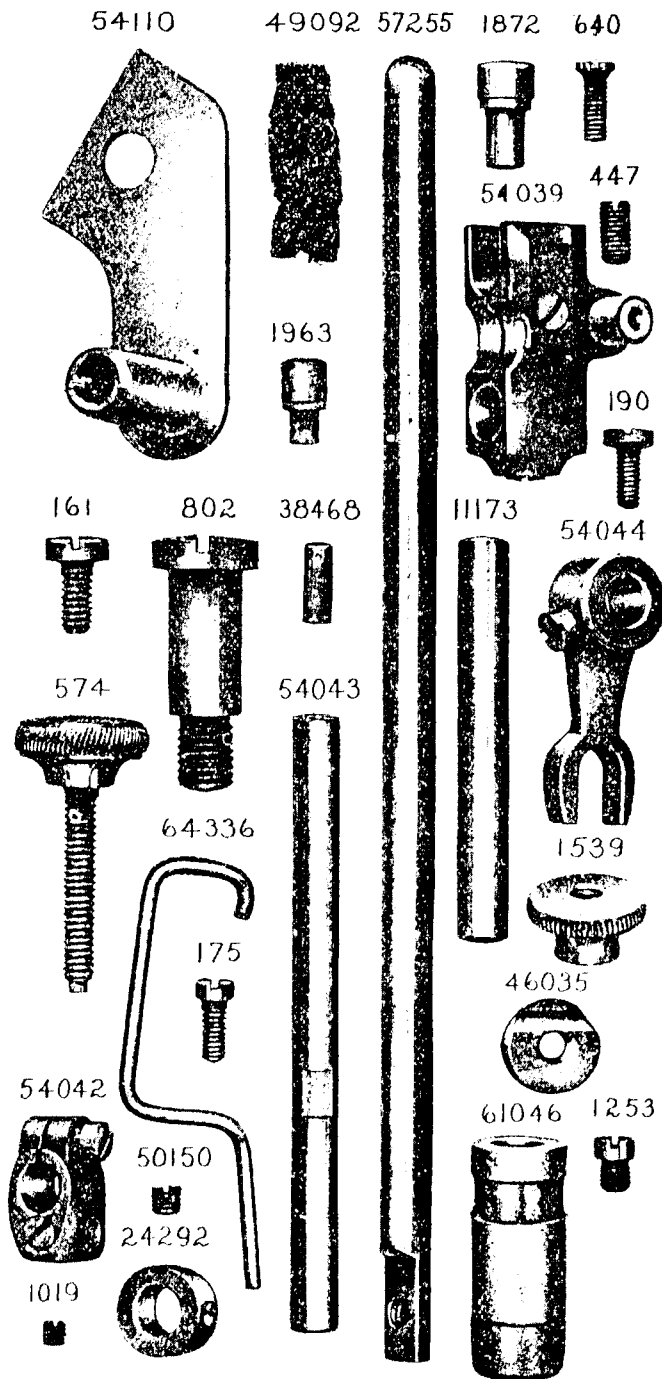


PLATE 8909—FULL SIZE

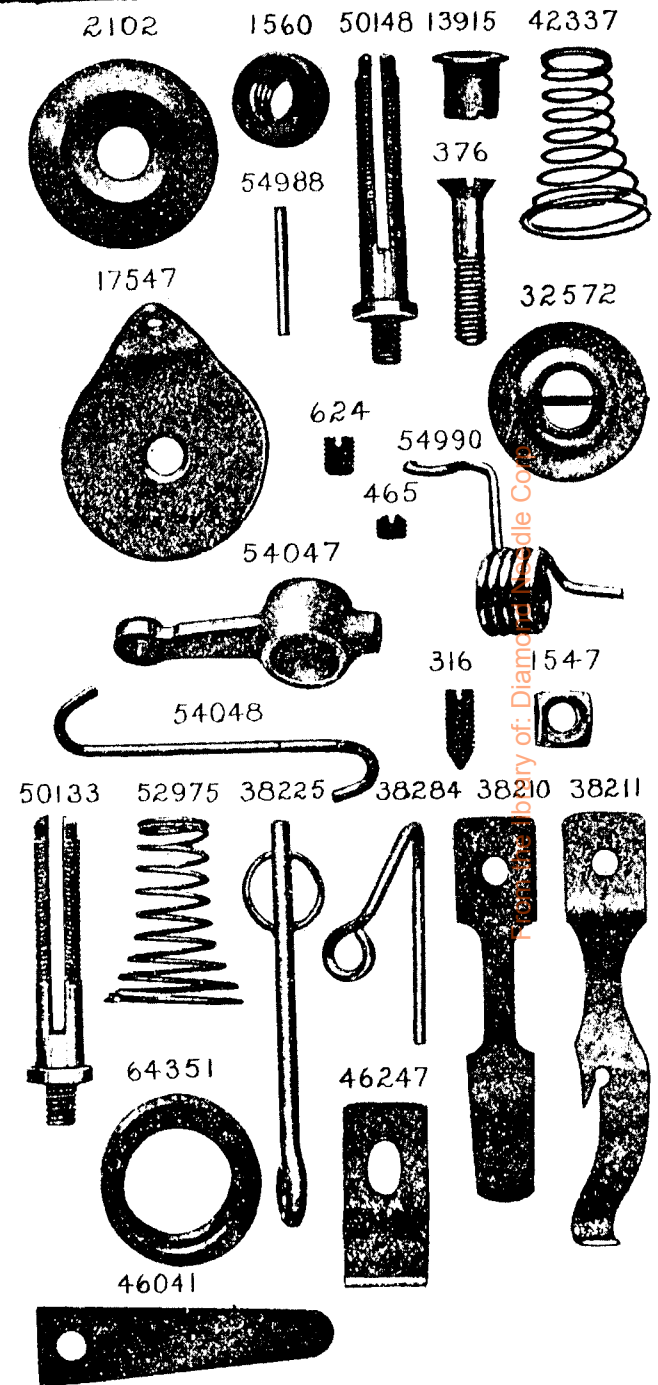


PLATE 8910—FULL SIZE

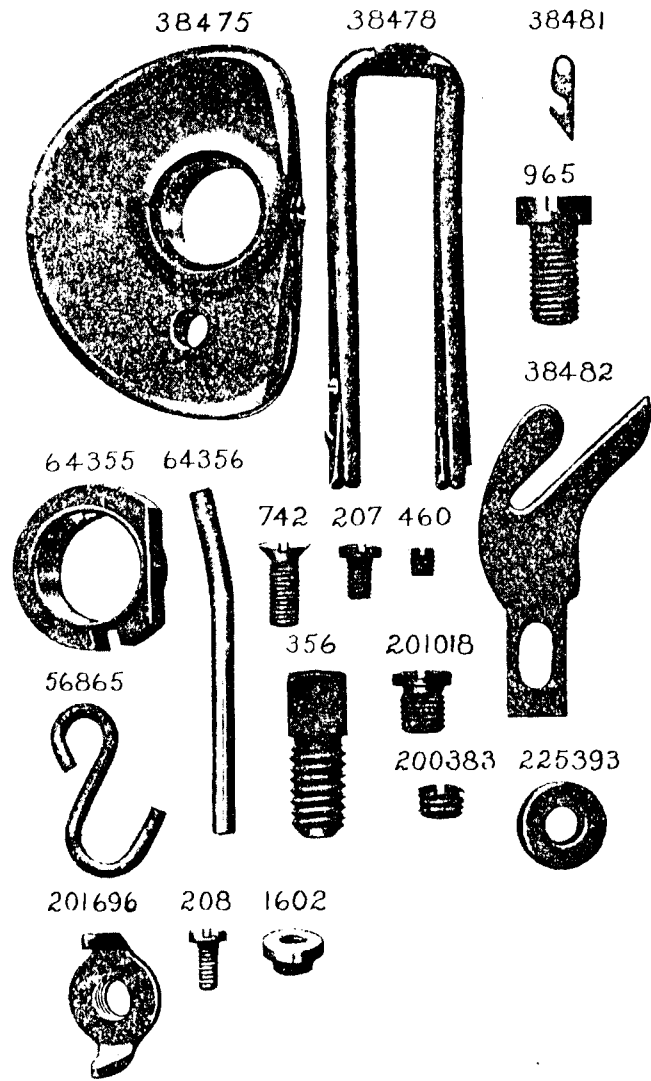
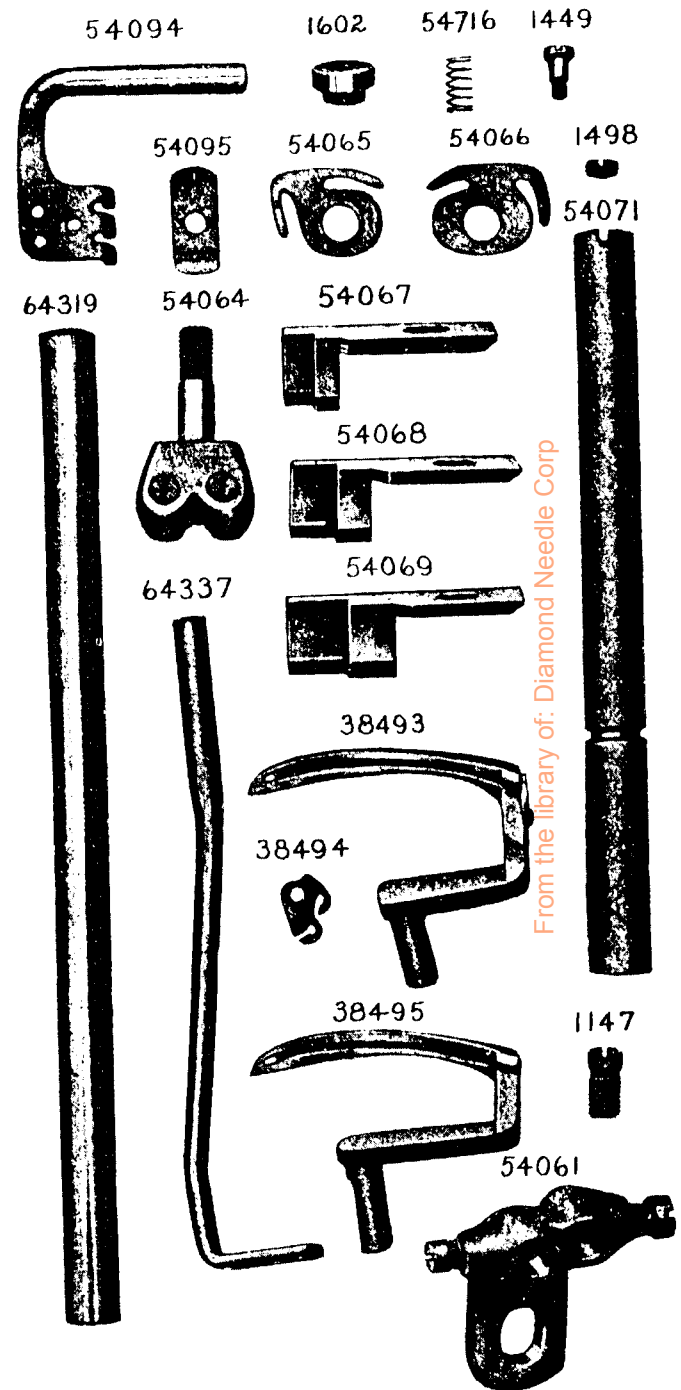


PLATE 8922—FULL SIZE



From the library of: Diamond Needle Corp



PLATE 8923—FULL SIZE

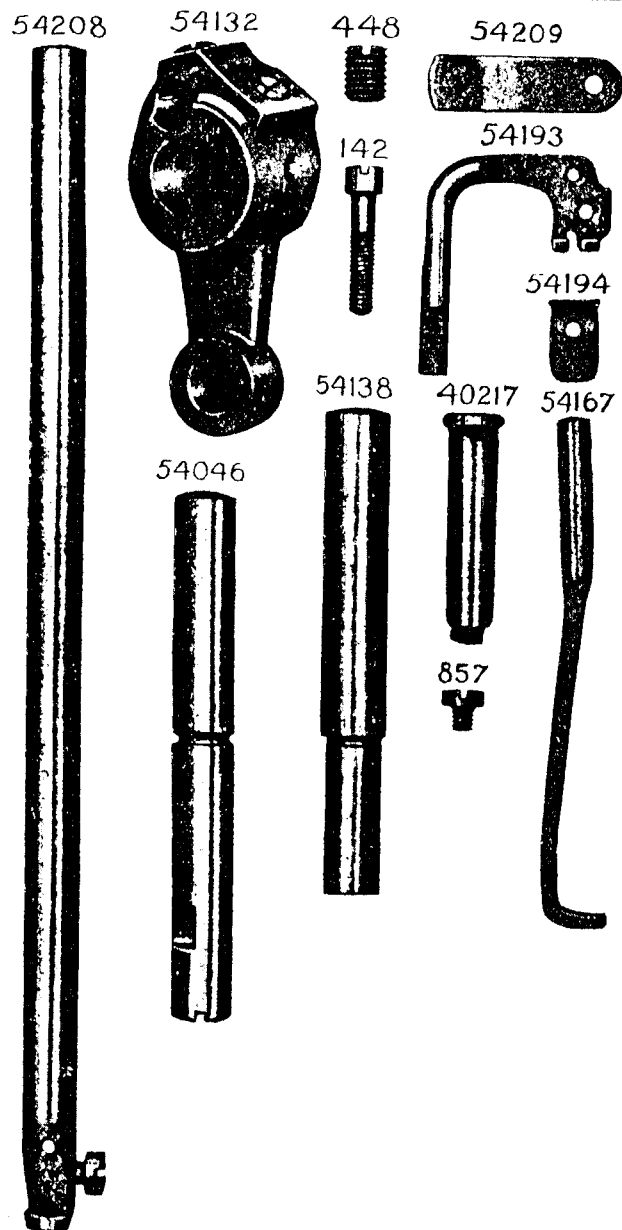
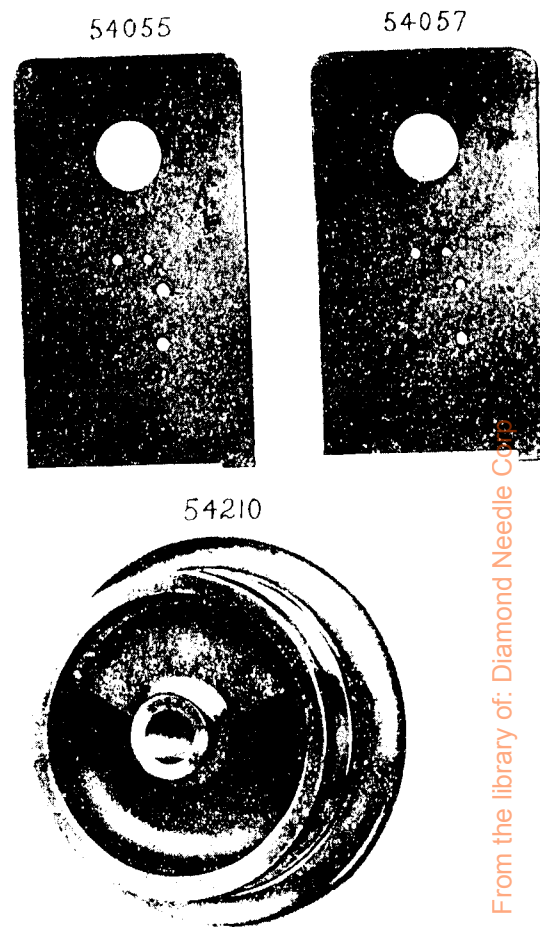


PLATE 8924—ONE-HALF SIZE



From the library of: Diamond Needle Co.

PLATE 8925—ONE-HALF SIZE

54131 54155 54140 54165 54157

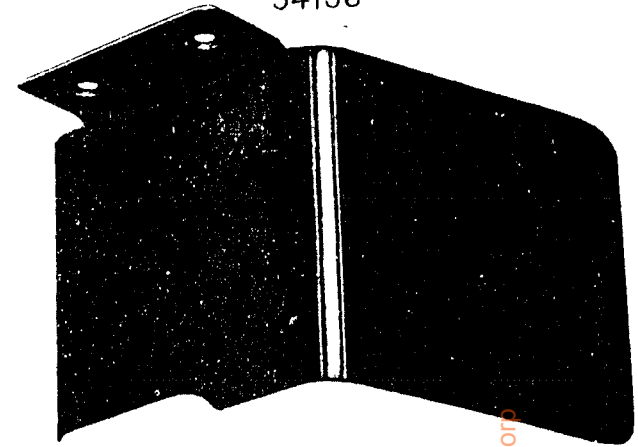


54133

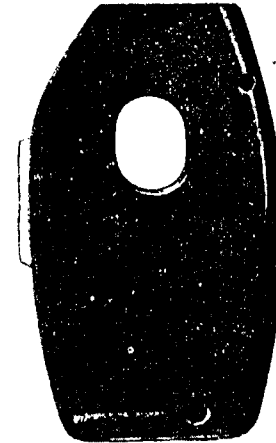


PLATE 8926—ONE-HALF SIZE

54136



54137



From the library of: Diamond Needle Corp



PLATE 8927—FULL SIZE

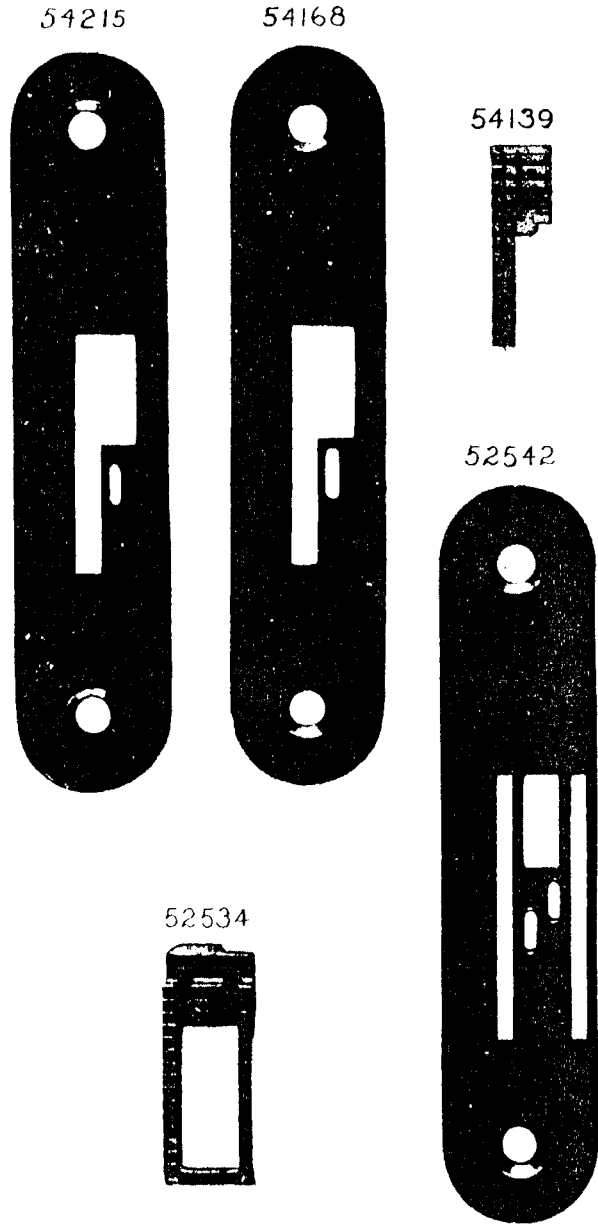


PLATE 8928—FULL SIZE

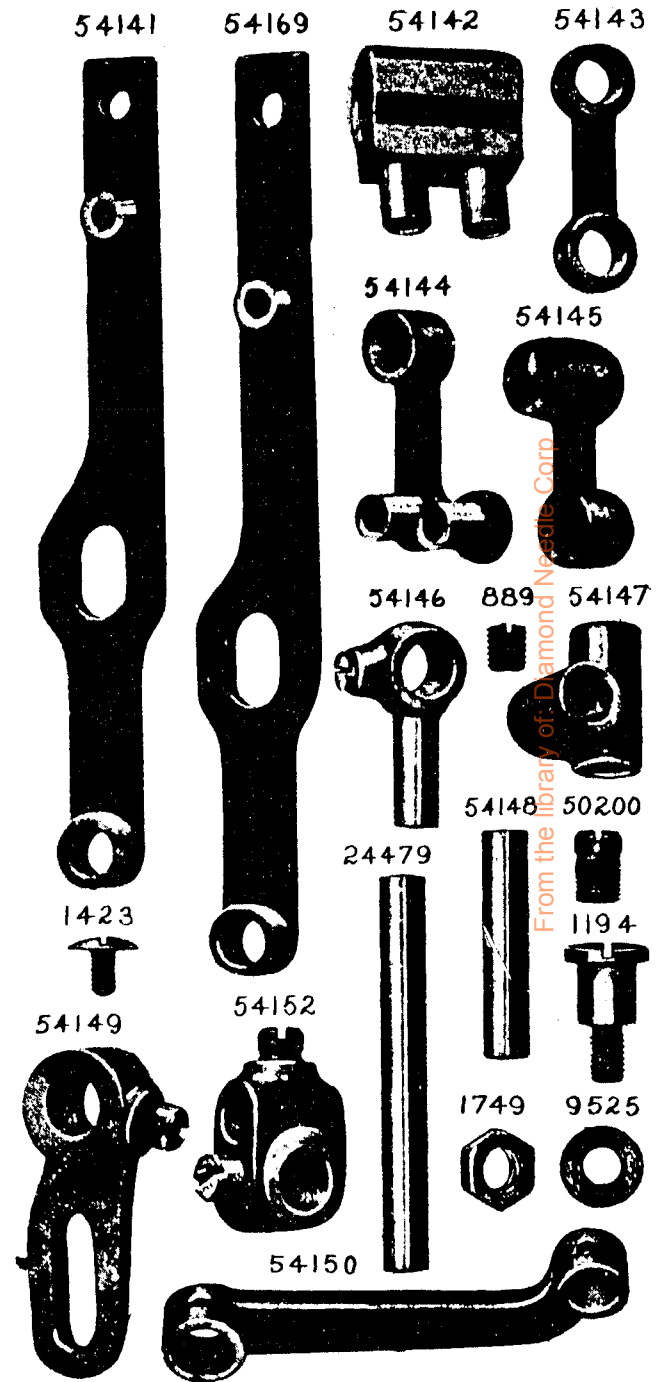


PLATE 8929—FULL SIZE

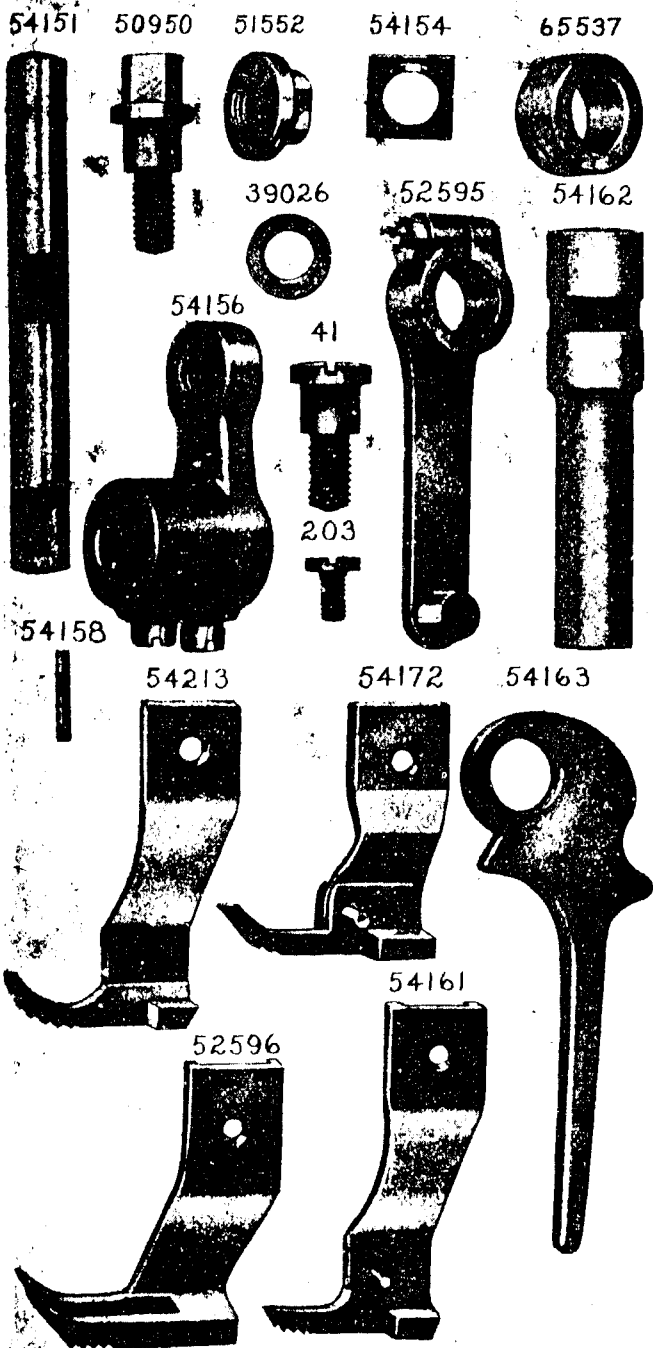
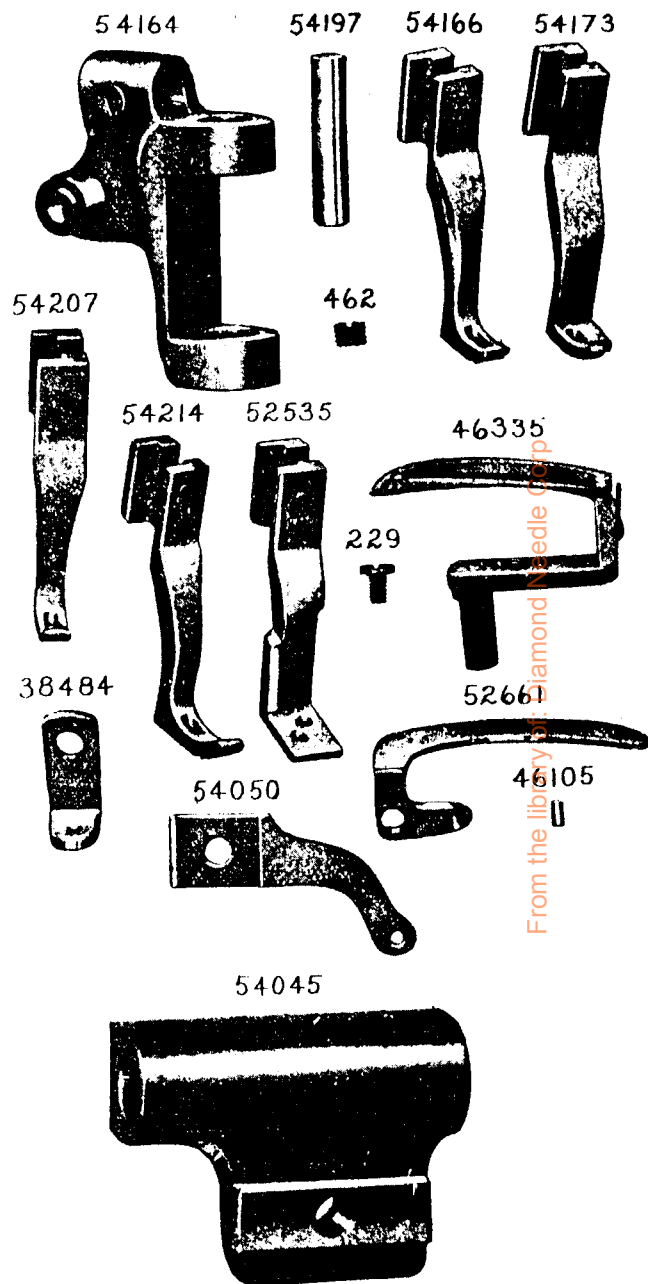


PLATE 8930—FULL SIZE



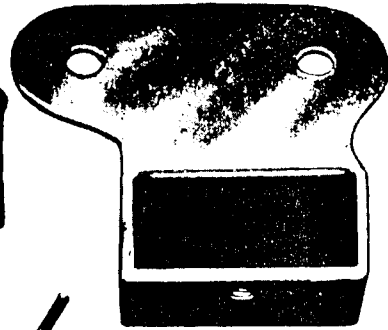
From the library of the Diamond Needle Corp

PLATE 8931—FULL SIZE

54070



54204



57629



54205



54072

46009

64357



46047

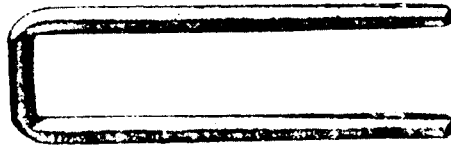
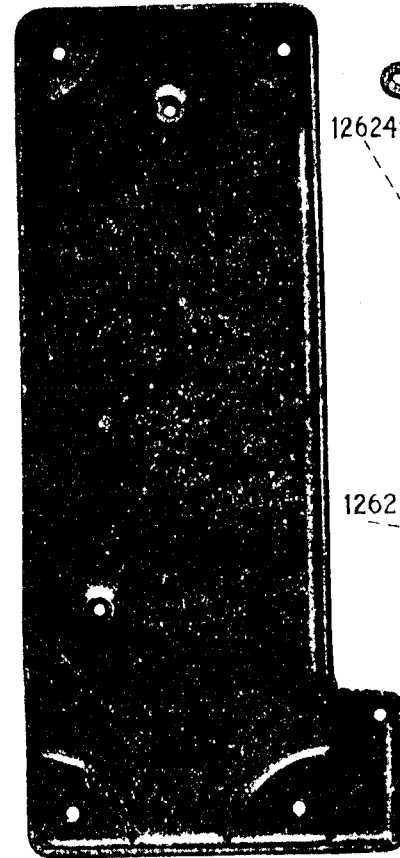


PLATE 8939—ONE-FOURTH SIZE

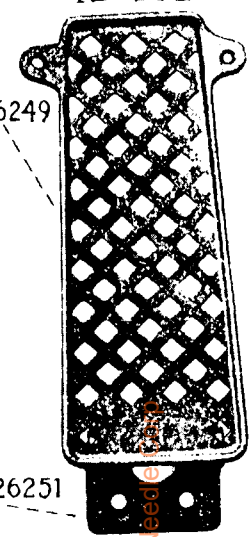
54091



126252

126249

126251



54052



From the library of: Diamond Needle

PLATE 8940—FULL SIZE

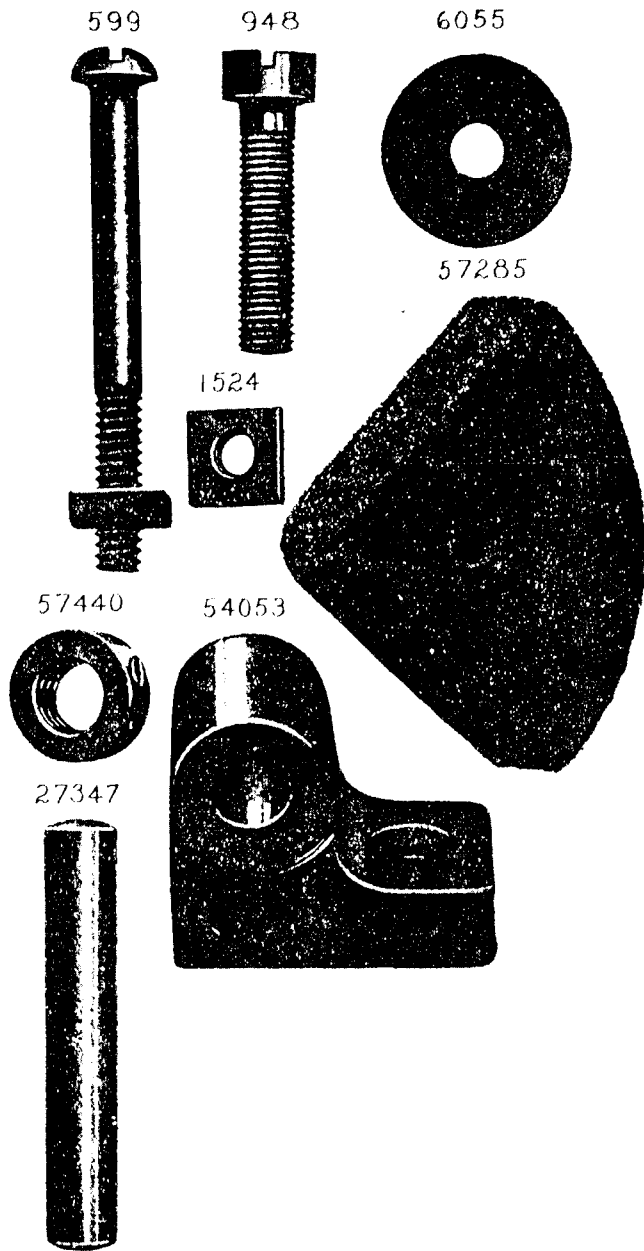


PLATE 8941—ONE-HALF SIZE

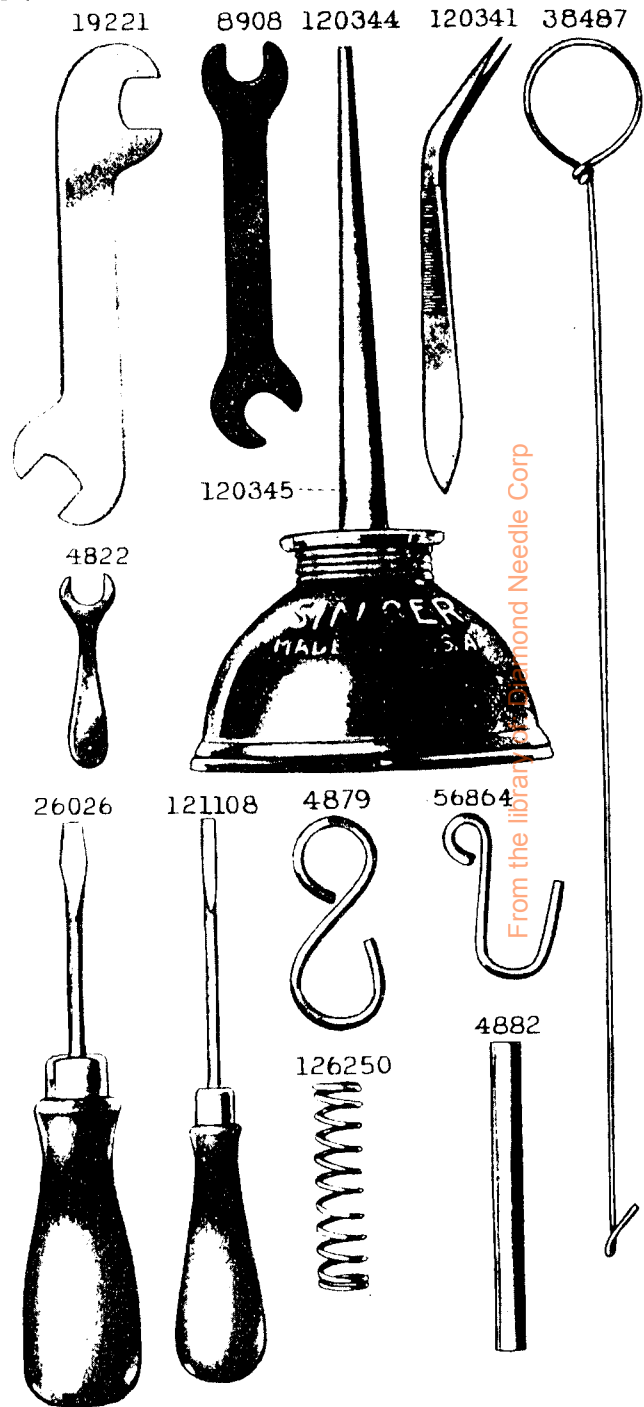


PLATE 8942—FULL SIZE

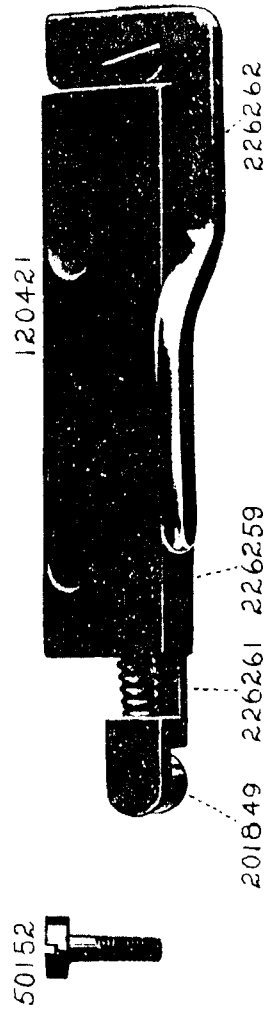


PLATE 8952—FULL SIZE

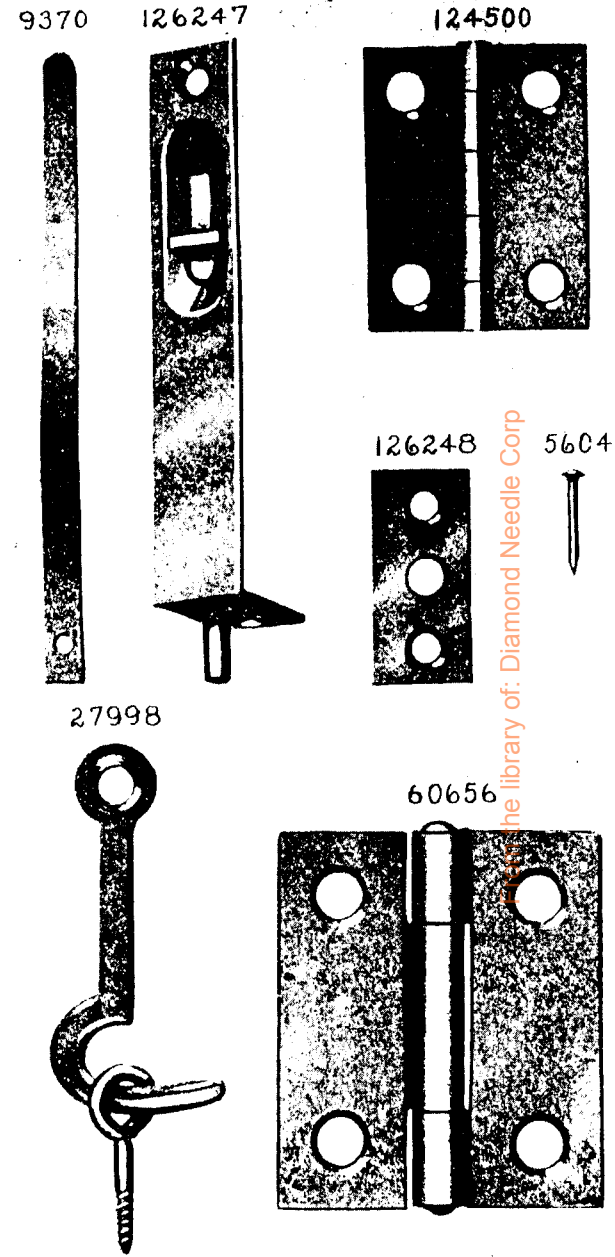


PLATE 8953—ONE-FOURTH SIZE

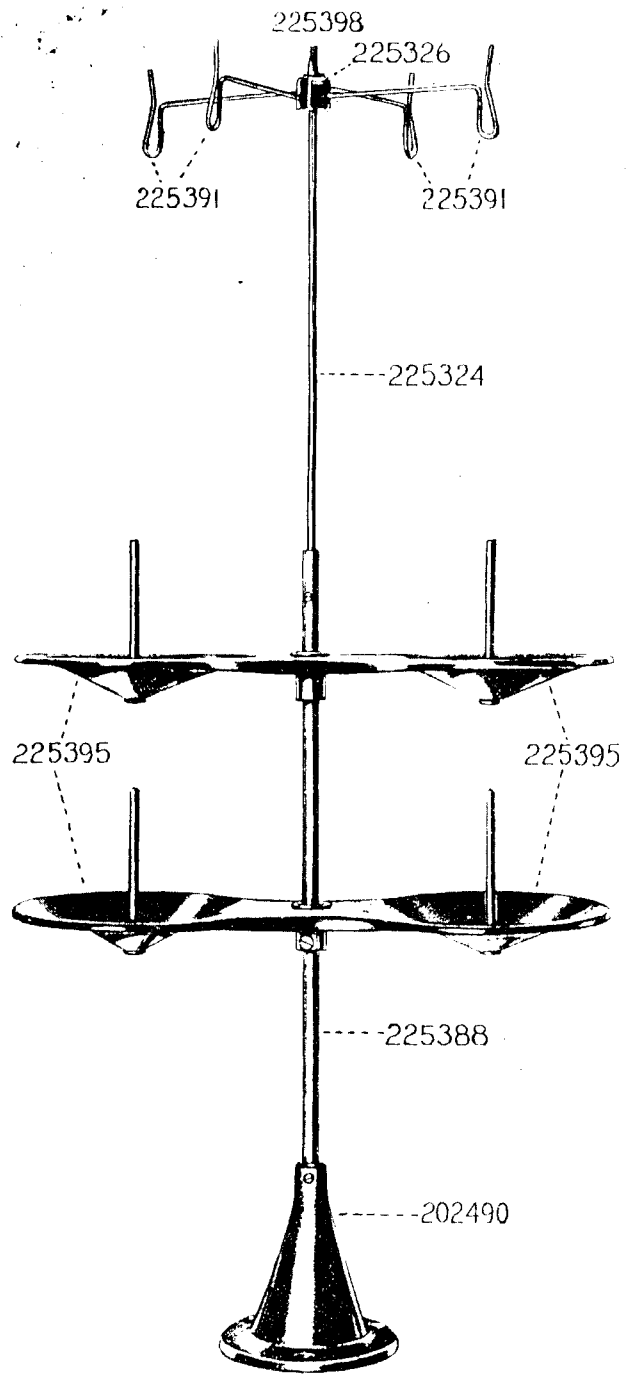
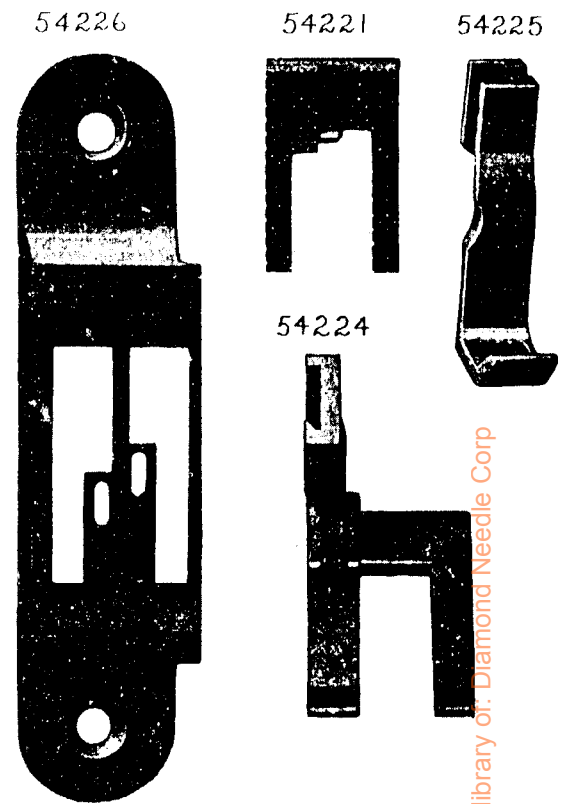


PLATE 8954—FULL SIZE



From the library of: Diamond Needle Corp